



# 4 Door Remote Prep Table Supreme Specifications

Model No. BM96S-R

Phone: (631) 226-6688  
FAX: (631) 226-6890

side view

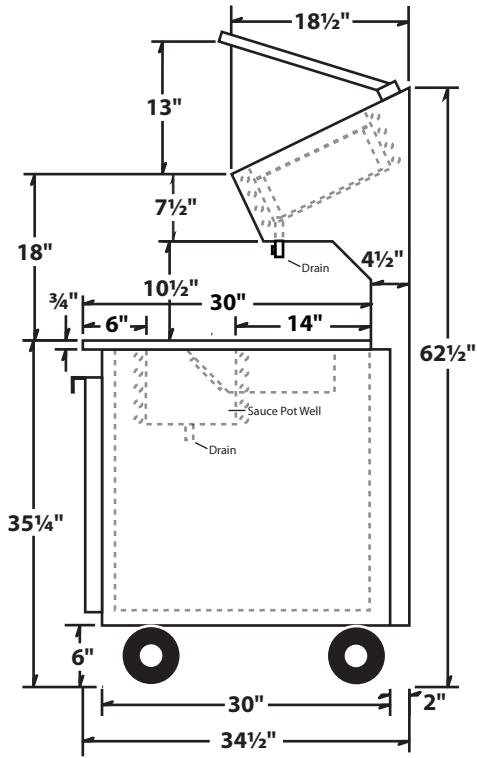

top view

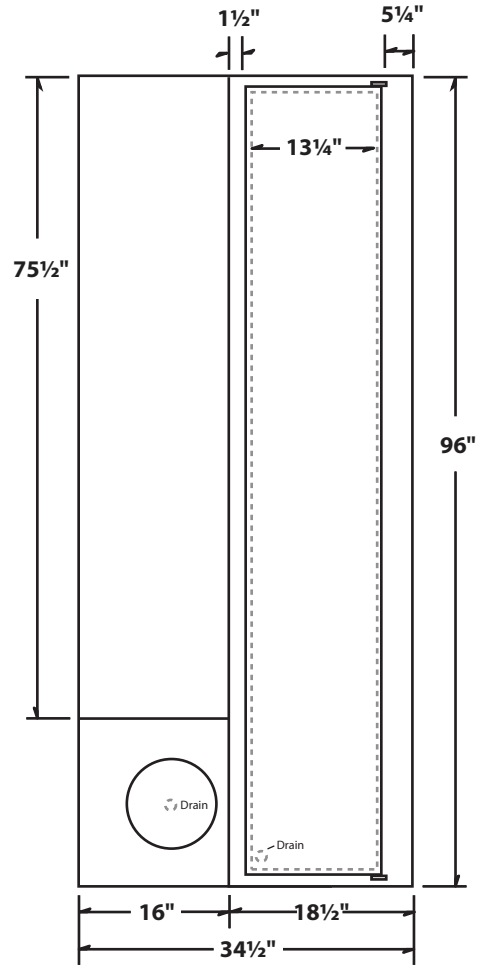

front view

